

# SS3



**Caliber**  
7.62 mm



**Effective Range**  
400 m (Mechanical)  
800 m (Optical)



**Capacity**  
20 rounds



**Locking System**  
Rotated

### Dimension

- Length (stock extended) : 1,080 - 1,150 mm
- Length (stock folded) : 836 mm
- Barrel Length : 500 mm

**Operating Principle**  
Gas Operated



**Operating Principle**  
Gas Operated

**Silencer**



**Operating Principle**  
Gas Operated

## SS2-SUBSONIC



**Caliber**  
5.56 mm



**Capacity**  
30 rounds



**Effective Range**  
150 m

## SS2-V5



**Caliber**  
5.56 mm



**Capacity**  
30 rounds



**Effective Range**  
200 m



**Operating Principle**  
Gas Operated



**Operating Principle**  
Gas Operated

## SS2-V4 HB



**Caliber**  
5.56 mm



**Capacity**  
30 rounds



**Effective Range**  
600 m (Optical)  
400 m (Mechanic)

## SS2-V2 HB



**Caliber**  
5.56 mm



**Capacity**  
30 rounds



**Effective Range**  
600 m (Optical)  
400 m (Mechanic)



# PISTOL

## PISTOL G2 PREMIUM

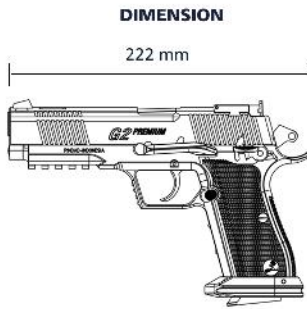

DIMENSION

222 mm

147 mm



Safety System  
Hammer Lock

Accessory

Operating Principle  
- Single Action  
- Semi Automatic

### AVAILABLE COLORS



Gold



Silver



Black



Caliber  
9 mm



Capacity  
15 rounds



Effective Range  
25 m



Operating Principle  
- Single Action  
- Semi Automatic



Operating Principle  
Double Action

## PISTOL MAG.4



Caliber  
9 mm



Capacity  
15 rounds



Effective Range  
15 m

## PISTOL P3-A



Caliber  
7.65 mm



Capacity  
15 rounds



Effective Range  
15 m



2008 - 2018  
**AASAM**  
Australian Army at Arms Meeting



2008 - 2014  
2016 - 2018  
**AARM**  
ASEAN Armies Rifle Meet



Operating Principle  
- Single Action  
- Semi Automatic



Operating Principle  
- Single Action  
- Semi Automatic

## PISTOL G2-ELITE



Caliber  
9 mm



Capacity  
15 rounds



Effective Range  
25 m



Caliber  
9 mm



Capacity  
15 rounds



Effective Range  
25 m

## PISTOL G2-COMBAT



# SPR-4

Lighter Material

Optical Sight

## Dimension

- Weight : 11.5 kg
- Length : 1,298 mm
- Barrel Length : 685.8 mm



Caliber  
.338 inch



Effective Range  
1,500 m



Capacity  
5 rounds



Operating Principle  
Bolt Action

# SPR-3

Optical Sight

## Dimension

- Weight : 9.99 kg
- Length : 1,237 mm
- Barrel Length : 660 mm



Operating Principle  
Bolt Action/Repeater



Caliber  
7.62 mm



Capacity  
10 rounds



Effective Range  
900 m

# SPR-2

Optical Sight

## Dimension

- Weight : 20.10 kg
- Length : 1,755 mm
- Barrel Length : 1,055 mm



Operating Principle  
Bolt Action/Repeater



Caliber  
12.7 mm



Capacity  
5 rounds



Effective Range  
2,000 m



# SM2-V2

## Dimension

- Weight : 12 kg (with coaxial)
- Length : 1,070 mm
- Barrel Length : 587 mm



Caliber  
7.62 mm



Feed  
Link Belt



Effective Range  
1,000 m

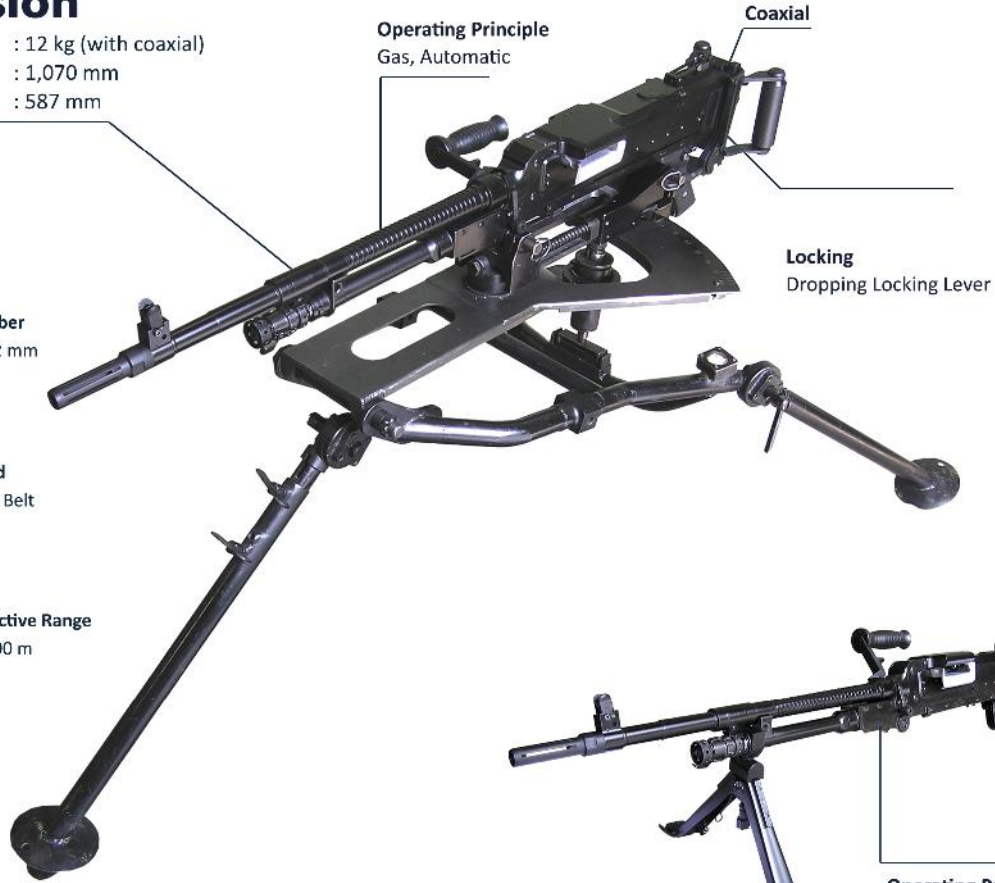

## SM2-V1



Caliber  
7.62 mm



Feed  
Link Belt



Effective Range  
1,000 m



## SM3



Caliber  
5.56 mm



Feed  
Link Belt



Effective Range  
1,000 m

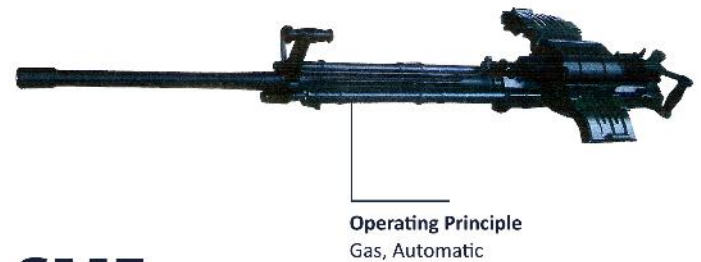

## SM5



Caliber  
12.7 mm



Feed  
Link Belt



Effective Range  
1,830 m



## ANOA 6x6 AMPHIBIOUS TYPE

### Specification



**Engine**  
Diesel Engine in line 6 cylinder



**Fuel Capacity**  
260 L



**Power**  
320 HP



**Range**  
600 km

### Dimension

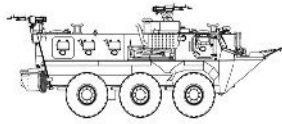

7.6 m

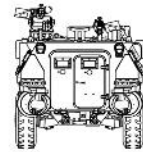

2.5 m

2.67 m

### Crew



**10**  
persons



**APC Type**



**Ambulance Type**



**Logistic Type**



# KOMODO 4x4 APC TYPE

## ■ Specification



**Engine**  
Diesel Engine in line 4 cylinder



**Fuel Capacity**  
200 L



**Power**  
215 HP



**Range**  
600 km

## Dimension



5.9 m

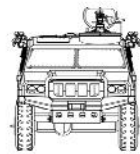

2.3 m

2.2 m

## Crew



**2+10**  
persons

### Communication

- Intercom Set & VHF/FM
- GPS

### Armament Mounting

### Grenade Launcher

### Speed

- 80 km/h on highway
- 30 km/h on off road



**Recon Type**



**Missile Launcher Type**



**Battering Ram Type**



## BADAK 6x6 CANNON 90 mm

### ■ Specification



**Engine**  
Diesel Engine in line 6 cylinder



**Fuel Capacity**  
200 L



**Power**  
340 HP



**Range**  
600 km

**Balistic Protection**  
7.62 mm Bulletproof Steel Plat

### Dimension

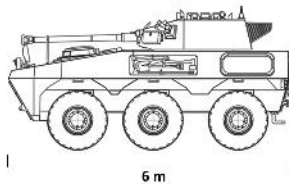

6 m

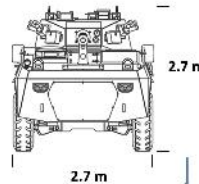

2.7 m

### 3 Crew



- Commander
- Driver
- Shooter



- Two-Man Turret caliber 90 mm
- Wide Range Ammunition and Target Effects
- High Mobility
- Balistic Protection : Standard 7.62 mm NATO
  - Basic : STANAG 4569-level 1
  - Maximum : STANAG 4569-level 3







# AMMUNITION

## MU5-TJ LINK (4MU5-TJ + 1 MU5-N LINK)

**MU5-TJ**

 **Caliber**  
5.56x45 mm

 **Dimension**  
Length : 57.40 mm  
Weight : 12.25 gram  
Headspace : 38.10 mm

 **Average Velocity**  
915 m/s (@ 25 m)

**Case**  
Length : 44.70 mm  
Extractor Diameter : 8.44 mm  
Rim Diameter : 9.60 mm  
Material : Brass

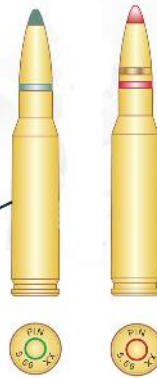

**MU5-N**

 **Caliber**  
5.56x45 mm

 **Dimension**  
Length : 57.40 mm  
Weight : 12.00 gram  
Headspace : 38.10 mm

 **Average Velocity**  
870 m/s (@ 25 m)



**MU5-S**

 **Caliber**  
5.56x45 mm

 **Dimension**  
Length : 57.40 mm  
Weight : 10.67 gram  
Headspace : 38.10 mm

 **Average Velocity**  
410 m/s (@ 10 m)



**MU2-TJS**

 **Caliber**  
7.62x51 mm

 **Dimension**  
Length : 71.12 mm  
Weight : 25.15 gram  
Headspace : 41.50 mm

 **Average Velocity**  
820 m/s (@ 0 m)



**MU1-TJ**

 **Caliber**  
9x19 mm

 **Dimension**  
Length : 29.70 mm  
Weight : 12.28 gram

 **Average Velocity**  
380 m/s (@ 12.5 m)



**MU3-BLAM**

 **Caliber**  
12.7x99 mm

 **Dimension**  
Length : 138.43 mm  
Weight : 118.00 gram  
Headspace : 79.86 mm

 **Average Velocity**  
900 m/s (@ 0 m)